

Features and Benefits

- Ultra Low Loss, less than 0.5 dB insertion loss from DC to 95 GHz
- Ideal thermal performance due to solid copper construction
- Chip interface compatible with automated Au wire bonding
- PCB interface compatible with standard SMT processes

Applications

- Military
- Space
- Communications
- Instrumentation

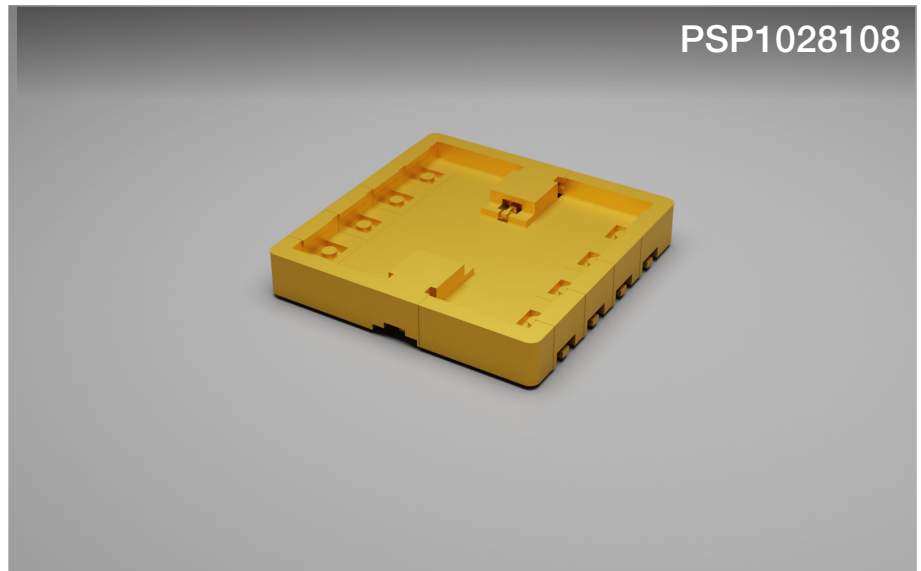

PolyStrata® Package: PSP1028108

Market-leading lowest loss, surface mount form factor package for die under 1.6 x 1.6mm up to 95 GHz.

Cubic Nuvotronics presents a new state of the art Low Loss MMIC package. The PolyStrata® package complements integrated MMIC performance, with less than 0.5 dB insertion loss up to 95 GHz and 20 dB return loss. The package can be surface mounted to a PCB using standard SMT processes. This increases the ease of manufacturing while maintaining superior performance in a smaller size compared to other packaging substrates.

Typical Electrical Performance

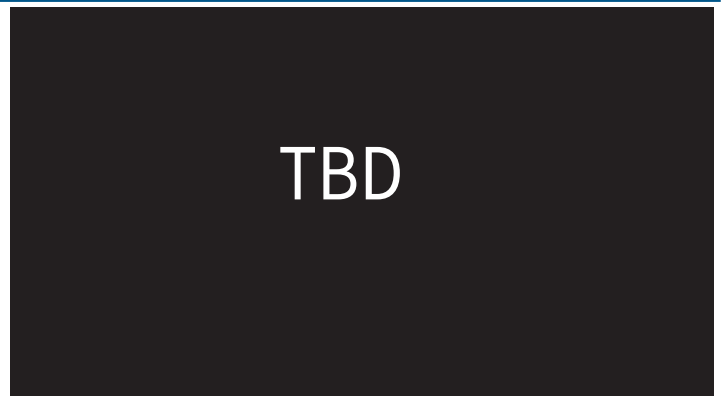
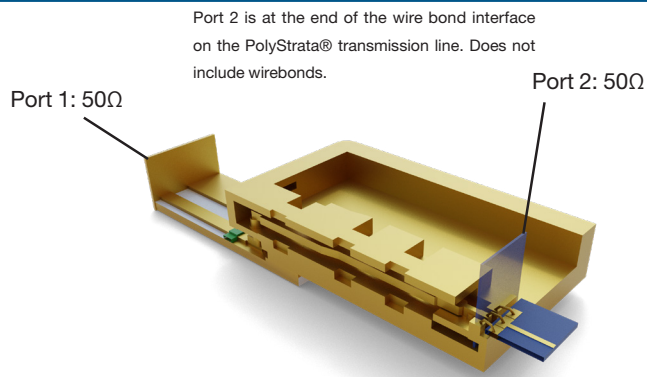

Additional Details

Special Handling / Storage Instructions (Substrate Only)	
Storage	Per JEP160 - Oxygen Sensitive Devices
EDS Sensitivity	None
Moisture Sensitivity	Not Applicable
Component Termination Finish	Immersion Gold over Immersion Silver
Packaging Available	Gel-Pak®, Tape and Reel
Ordering Part Number	PSP1028108
Export Classification	EAR99
Lid Options	Compatible with metal or plastic lids, and most lid-sealing processes

Absolute Maximum Ratings

Current	2.0 amps
Operating Temp	-55°C to 125°C
Solder Reflow	Compatible with JEDEC J-STD-020
Epoxy Attach	150°C max. for 90 minutes

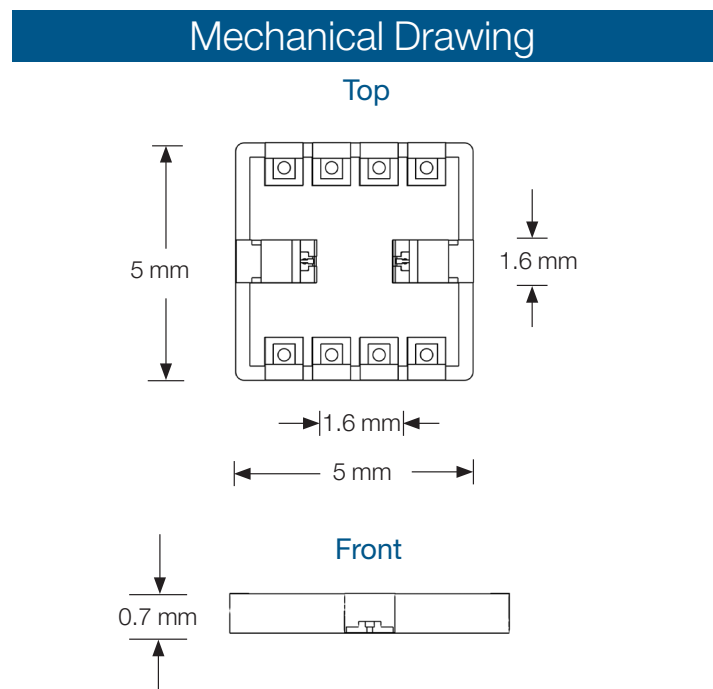
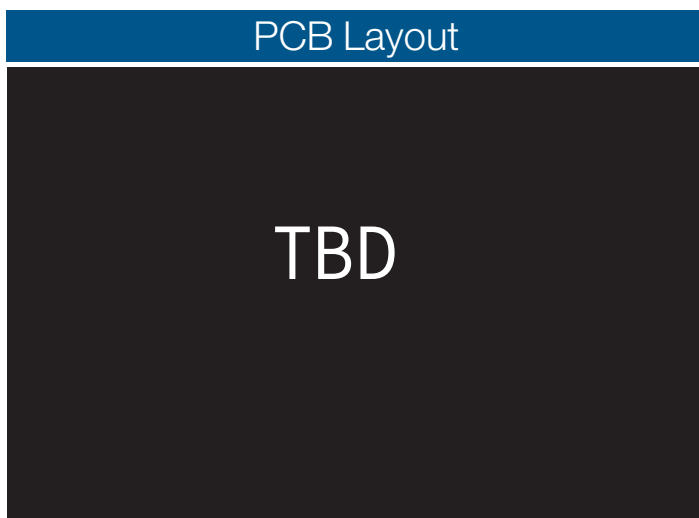
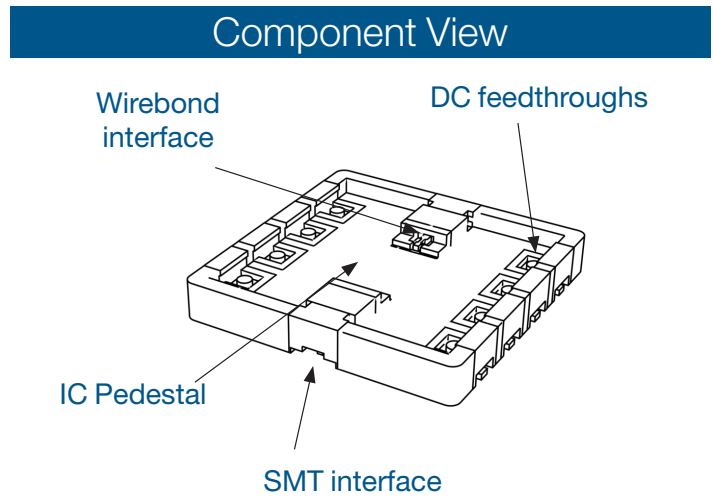
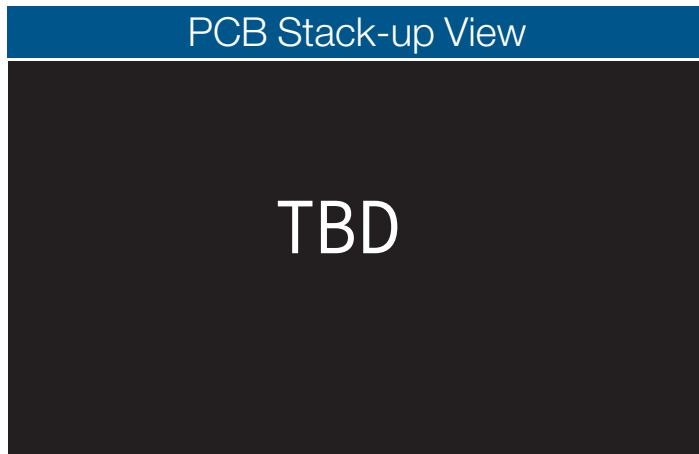

3D models, S-parameters, board footprint
DXF drawings available on request